



Low Cost, Single and Multichannel Isolation Amplifier

MODEL 290A, 292A

FEATURES

Low Cost

Multichannel Capability Using External Oscillator (292A)
Isolated Power Supply: $\pm 13\text{V dc}$ @ $\pm 5\text{mA}$ (290A) or $\pm 15\text{mA}$ (292A)

Low Nonlinearity: 0.1% @ 10V pk-pk Output
High Gain Stability: $0.001\%/1000$ Hours; $0.01\%/^{\circ}\text{C}$
Small Size: $1.5" \times 1.5" \times 0.62"$
Low Input Offset Voltage Drift: $10\mu\text{V}/^{\circ}\text{C}$ (Gain = 100V/V)
Wide Input/Output Dynamic Range: 20V pk-pk
High CMV Isolation: 1500V dc , Continuous
Wide Gain Range: 1 to 100V/V

APPLICATIONS

Ground Loop Elimination in Industrial and Process Control
High Voltage Protection in Data Acquisition Systems
Fetal Heart Biomedical and Monitoring Instrumentation
Off-Ground Signal Measurements

GENERAL DESCRIPTION

Models 290A and 292A are low cost, compact, isolation amplifiers that are optimized for single and multichannel industrial applications, respectively. The model 290A has a self-contained oscillator and is intended for single channel applications. A single external synchronizing oscillator can drive up to 16 model 292A's or, a virtually limitless number of model 292A's can be configured using multiple oscillators. The user can supply the external oscillator circuit or specify model 281 oscillator module, which includes a voltage regulator for operation over a wide single supply voltage range of $+8\text{V}$ to $+28\text{V}$.

Models 290A and 292A design features include: adjustable gain, from 1 to 100V/V , dual isolated power, $\pm 13\text{V dc}$, $\pm 1500\text{V dc}$ off ground isolation, 100dB minimum CMR at 60Hz , $1\text{k}\Omega$ source imbalance, in a compact $1.5" \times 1.5" \times 0.6"$ module. Models 290A and 292A achieve low input noise of $1\mu\text{V pk-pk}$ (10Hz bandwidth, $G = 100\text{V/V}$), nonlinearity of $\pm 0.1\%$ @ 10V pk-pk output, and an input/output dynamic range of 20V pk-pk .

Using modulation techniques with reliable transformer isolation, models 290A and 292A will interrupt ground loops, leakage paths, and voltage transients, while providing dc to 2kHz (-3dB) response.

WHERE TO USE MODELS 290A AND 292A

Industrial Applications: In data acquisition systems, computer interface systems, process signal isolators and high CMV instrumentation, models 290A and 292A offer complete galvanic isolation and protection against damage from transients and fault voltages. High level transducer interface capability is afforded

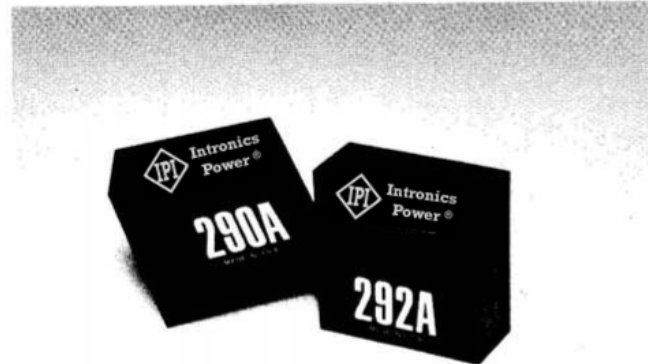

with 20V pk-pk input signal range at a gain of 1V/V operation. In portable single or multichannel designs, single power supply operation ($+8\text{V}$ to $+16\text{V}$) enables battery operation.

DESIGN FEATURES AND USER BENEFITS

Isolated Power: Dual $\pm 13\text{V dc}$ output, completely isolated from the input power terminals ($\pm 1500\text{V dc}$ isolation), provides the capability to excite floating signal conditioners, front end buffer amplifiers and remote transducers such as thermistors or bridges.

Adjustable Gain: Models 290A and 292A adjustable gain offers compatibility with a wide class of input signals. A single external resistor enables gain adjustment from 1V/V to 100V/V providing flexibility in both high level transducer interfacing as well as low level sensor measurement applications.

Floating, Guarded Front-End: The input stage of models 290A and 292A can directly accept floating differential signals or it may be configured as a high performance instrumentation front-end to accept signals having CMV with respect to input power common.

High Reliability: Models 290A and 292A are conservatively designed, compact modules, capable of reliable operation in harsh environments. They have a calculated MTBF of over 400,000 hours and are designed to meet MIL-STD-202E environmental testing as well as the IEEE Standard for Transient Voltage Protection (472-1974: Surge Withstand Capability).

SPECIFICATIONS

(typical @ +25°C; G = 100V/V and V_S = +15V dc, unless otherwise noted)

| MODEL | 290A | 292A |
|--|---|-----------------------------|
| GAIN (NONINVERTING) | | |
| Range (50kΩ Load) | 1 to 100V/V | |
| Formula | Gain = $\left[1 + \frac{100k\Omega}{1k\Omega + R_i (k\Omega)} \right]$ | |
| Deviation from Formula | ±3% | |
| vs. Time | ±0.001%/1000 Hours | |
| vs. Temperature (-25°C to +85°C) ¹ | ±0.0075%/°C | |
| Nonlinearity, G = 1V/V to 100V/V ² | ±0.1% (±0.25%) ³ | |
| INPUT VOLTAGE RATINGS | | |
| Linear Differential Range, G = 1V/V | ±5V min (±10V min) ³ | |
| Max Safe Differential Input | 110V rms | |
| Continuous, 1 min | 1500V rms max | |
| Max CMV, Inputs to Outputs | ±1000V pk max | |
| ac, 60Hz, 1 Minute Duration | ±1500V pk max | |
| Continuous, ac | | |
| Continuous, dc | | |
| CMR, Inputs to Outputs, 60Hz, R _S ≤ 1kΩ | 106dB | |
| Balanced Source Impedance | 100dB min | |
| 1kΩ Hi In Lead Only | | |
| Max Leakage Current, Inputs to Power Common | 10μA rms max | |
| @ 115V ac, 60Hz | | |
| INPUT IMPEDANCE | | |
| Differential | 10 ⁸ Ω 70pF | |
| Overload | 100kΩ | |
| Common Mode | 5 × 10 ¹⁰ Ω 100pF | |
| INPUT DIFFERENCE CURRENT | | |
| Initial, @ +25°C | +3nA | |
| vs. Temperature (-25°C to +85°C) | ±0.1nA/°C | |
| INPUT NOISE | | |
| Voltage, G = 100V/V | | |
| 0.01Hz to 10Hz | 1μV p-p | |
| 10Hz to 1kHz | 1.5μV rms | |
| Current | | |
| 0.05Hz to 100Hz | 5pA p-p | |
| FREQUENCY RESPONSE | | |
| Small Signal, -3dB, G = 1V/V | 2.5kHz | |
| Slew Rate | 50mV/μs | |
| Full Power, 10V p-p Output | | |
| Gain - 1V/V thru 100V/V | 2.0kHz(1.0kHz) ³ | 3.0kHz(1.0kHz) ³ |
| OFFSET VOLTAGE REFERRED TO INPUT | | |
| Initial, @ +25°C, Adjustable to Zero | ±(5 + 50/G)mV | |
| vs. Temperature (-25°C to +85°C) | ±(10 + 150/G)μV/°C | |
| vs. Supply Voltage | ±1mV/% | |
| RATED OUTPUT | | |
| Voltage, 50k Load | ±5V min (±10V min) ³ | |
| Output Impedance | 1kΩ | |
| Output Ripple, 1MHz Bandwidth | 10mV pk-pk | |
| OSCILLATOR DRIVE INPUT | | |
| Input Voltage | N/A | 8 to 16V pk-pk |
| Input Frequency | N/A | 100kHz ±5%, max |
| ISOLATED POWER OUTPUTS | | |
| Voltage Full Load | ±13V dc | |
| Accuracy | ±5% | |
| Current ⁴ | ±5mA min | ±15mA min |
| Regulation, No Load to Full Load | +0, -15% | |
| Ripple, 100kHz Bandwidth | 200mV p-p | 250mV p-p |
| POWER SUPPLY, SINGLE POLARITY | | |
| Voltage, Rated Performance | +15V dc | |
| Voltage, Operating | +8V dc to +15.5V dc | |
| Current, Quiescent | +20mA | |
| TEMPERATURE RANGE | | |
| Rated Performance | -25°C to +85°C | |
| Storage | -55°C to +85°C | |
| CASE DIMENSIONS | | |
| | 1.5" X 1.5" X 0.62" | |

¹ Gain temperature drift is specified as a percentage of output signal level.
² Gain nonlinearity is specified as a percentage of 10V pk-pk output span.
³ These specs apply for a 20V pk-pk output span.
⁴ Do not load V_{ISO} when operating at output spans greater than 10V pk-pk.
 Specifications subject to change without notice.

OUTLINE DIMENSIONS

Dimensions shown in inches and (mm).

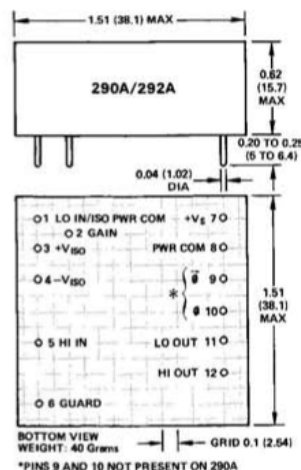

SHIELDED MOUNTING SOCKET AC1054

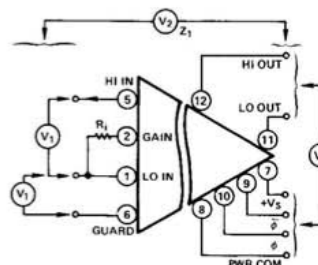
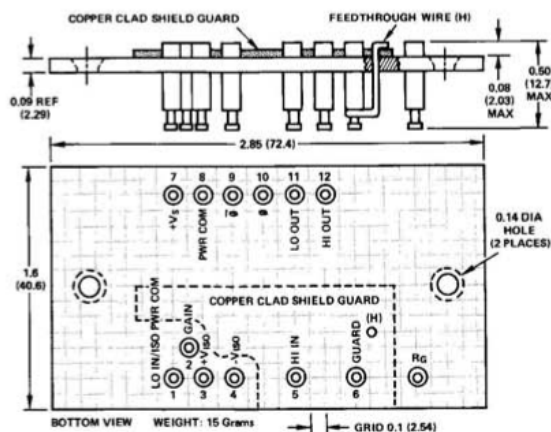

Figure 1. Model 290A and 292A Terminal Ratings

| Symbol | Rating | Remarks |
|----------------|--------------------|---------------------------------|
| V ₁ | ±110V rms (cont.) | Withstand Voltage, Steady State |
| V ₂ | ±1000V pk (cont.) | Isolation, Steady State, ac |
| V ₂ | ±1500V pk (cont.) | Isolation, Steady State, dc |
| V ₂ | ±1500V rms (1 min) | Isolation, ac, 60Hz |
| V ₃ | ±50V pk (cont.) | Isolation, dc |

Understanding the Isolation Amplifier Performance

THEORY OF OPERATION

The remarkable performance of models 290A and 292A are derived from the carrier isolation technique which is used to transfer both signal and power between the amplifier's guarded input stage and the rest of the circuitry. The block diagram for both models is shown in Figure 2 below.

The bipolar input preamplifier operates single-ended (non-inverting). Only a difference bias current flows with zero net bias current. A third wire return path for input bias current is not required. Gain can be set from 1V/V to 100V/V by changing the gain resistor, R_i . To preserve high CMR, the gain resistor must be guarded. Best performance is achieved by shorting terminal 2 to terminal 1 and operating the isolator at a gain of 100V/V.

For powering floating input circuitry such as buffer amplifiers, instrumentation amplifiers, calibration signals and transducers, dual isolated power is provided. High CMV isolation is achieved by the low-leakage transformer coupling between the input preamplifier, modulator section and the output circuitry. Only the 10pF leakage capacitance between the floating input section and the rest of the circuitry keeps the CMR from being infinite.

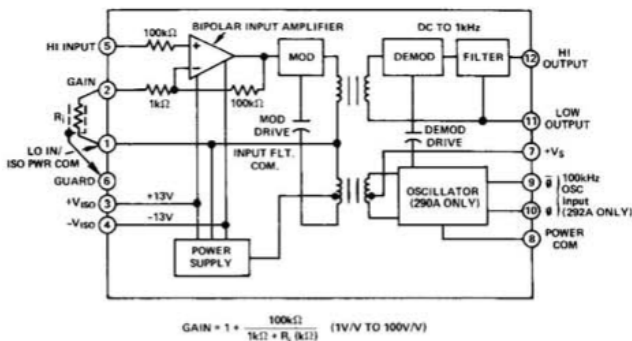

Figure 2. Block Diagram – Models 290A and 292A

GUIDELINES ON EFFECTIVE SHIELDING & GROUNDING PRACTICES

- Use twisted shielded cable to reduce inductive and capacitive pickup.
- Drive the transducer cable shield, S, with the common mode signal source, E_G , to reduce the effective cable capacitance as shown in Figure 3. This is accomplished by connecting the shield point S, as close as possible to the transducer signal low point B. This may not always be possible. In some cases the shield may be separated from signal low by a portion of the medium being measured (e.g. pressure transducer). This will cause a common mode signal, E_M , to be generated by the medium between the shield and the signal low. The 86dB CMR capability of both models between the input terminals (HI IN and LO IN) and GUARD, will work to suppress the common mode signal, E_M .

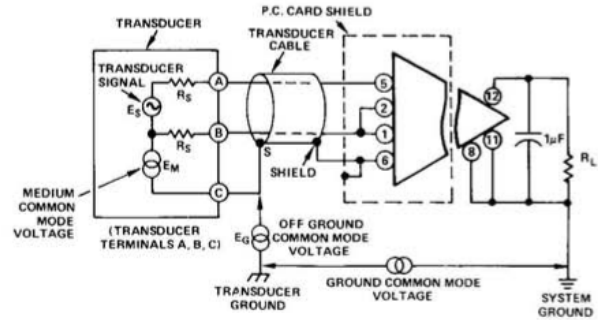
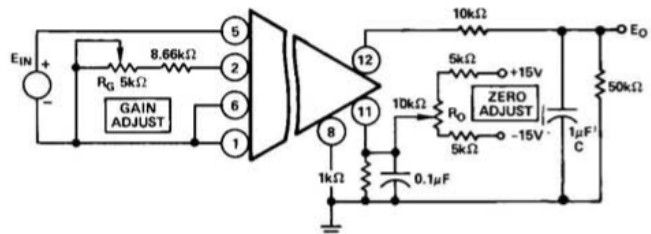
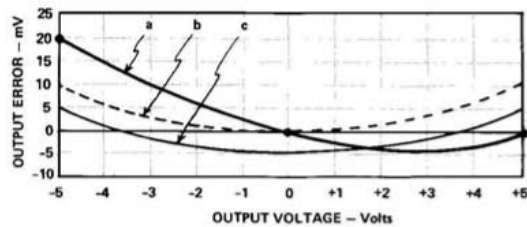

Figure 3. Transducer – Amplifier Interface

GAIN AND OFFSET TRIM PROCEDURE

In applying the isolation amplifier, highest accuracy is achieved by adjustment of gain and offset voltage to minimize the peak error encountered over the selected output voltage span. The following procedure illustrates a calibration technique which can be used to minimize output error. In this example, the output span is +5V to -5V and operation at Gain = 10V/V is desired.

1. Apply $E_{IN} = 0$ volts and adjust R_O for $E_O = 0$ volts.
2. Apply $E_{IN} = +0.5V$ dc and adjust R_G for $E_O = +5.0V$ dc.
3. Apply $E_{IN} = -0.5V$ dc and measure the output error (see curve a).
4. Adjust R_G until the output error is one half that measured in step 3 (see curve b).
5. Apply +0.5V dc and adjust R_O until the output error is one half that measured in step 4 (see curve c).



GAIN RESISTOR, R_i , 1%, 50ppm/°C METAL FILM TYPE IS RECOMMENDED. FOR GAIN = 1V/V, LEAVE TERMINAL 2 OPEN. FOR GAIN = 100V/V, SHORT TERMINAL 2 TO TERMINAL 1

$$GAIN = 1 + \frac{100k\Omega}{1k\Omega + R_i(1k\Omega)}$$

OUTPUT FILTER, 10kΩ RESISTOR AND CAPACITOR, C. SELECT C TO ROLL-OFF NOISE AND OUTPUT RIPPLE:

$$f = (-3dB) = \frac{1}{2\pi C (11k\Omega)}$$

SELECTING BANDWIDTH

In low frequency signal measurements, such as thermocouple temperature measurements, strain gage measurements and geophysical instrumentation, an external filter is used to select bandwidth and minimize output noise.

When used with a buffer amplifier as shown in Figure 5a below, a series resistor (R_S) is used to lower the effective value of the filter capacitor required to achieve very low frequency (under 200Hz) noise filtering.

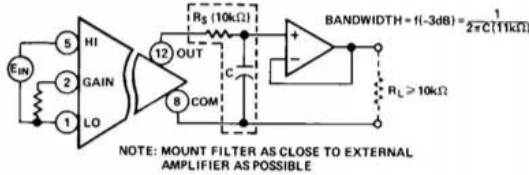

Figure 5a. Selecting Bandwidth with External Capacitor and Buffer

An active filter, as illustrated in Figure 5b will significantly improve 60Hz noise reduction at the output by providing a sharp roll-off characteristic. The 5Hz 3-pole active filter design illustrated in Figure 5b, will increase the 60Hz noise reduction by 50dB. Overall CMR performance of models 290 and 292 and the 5Hz active filter approaches 150dB @ 60Hz and 1kΩ imbalance.

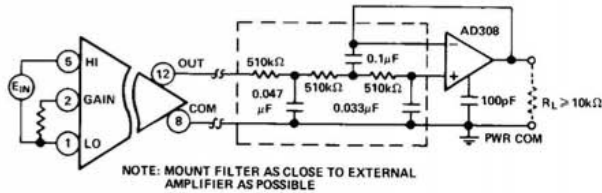

Figure 5b. Selecting Bandwidth with a 3-Pole 5Hz Active Filter

PERFORMANCE CHARACTERISTICS

Common Mode Rejection: Input-to-Output CMR is dependent on source impedance imbalance, signal frequency and amplifier gain. CMR is rated at 115V ac, 60Hz and 1kΩ imbalance at a gain of 100V/V. Figure 6 illustrates CMR performance as a function of signal frequency. CMR approaches 130dB at dc with source imbalances as high as 1kΩ. As gain is decreased, CMR is reduced. At a gain of 1V/V, CMR is typically 12dB lower than at a gain of 100V/V.

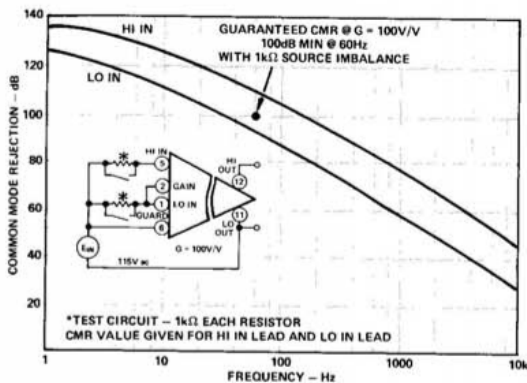

Figure 6. Typical Common Mode Rejection vs. Frequency

Figure 7 illustrates the effect of source imbalance on CMR per-

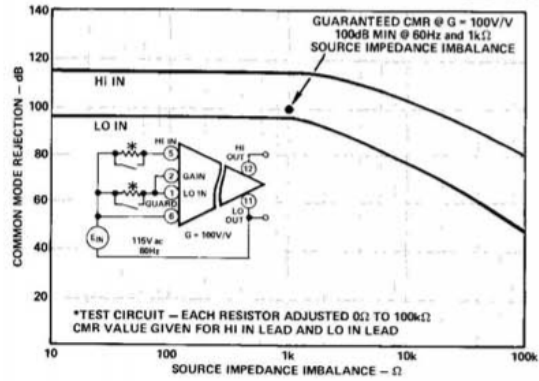

Figure 7. Typical Common Mode Rejection vs. Source Impedance Imbalance

Gain Nonlinearity: Linearity error is defined as the deviation of the output voltage from the best straight line and is specified as a % of peak-to-peak output voltage span; e.g., nonlinearity of models 290A and 292A operating at an output span of 10V pk-pk ($\pm 5V$) is $\pm 0.1\%$ or $\pm 10mV$. Figure 8 illustrates gain nonlinearity for any output span to 20V pk-pk ($\pm 10V$).

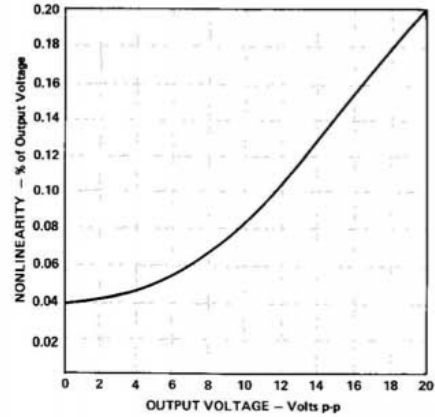
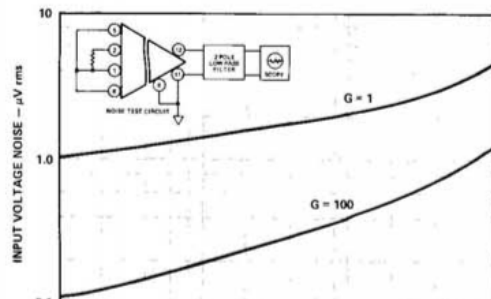

Figure 8. Typical Gain Nonlinearity vs. Output Voltage

Input Voltage Noise: Voltage noise, referred to input, is dependent on gain and bandwidth as illustrated in Figure 9. RMS voltage noise is shown in a bandwidth from 0.01Hz to the frequency shown on the horizontal axis. The noise in a bandwidth from 0.01Hz to 10Hz is 1μV pk-pk at a gain of 100V/V. This value is derived by multiplying the rms value at $f = 10Hz$ shown in Figure 9 by 6.6.

For best noise performance in particular applications, a low pass filter at the output should be used to selectively roll-off noise and undesired signal frequencies beyond the bandwidth of interest. Increasing gain will also reduce the input noise.



The Multi-Channel Isolation Amplifier

Input Offset Voltage Drift: Total input drift is composed of two sources, input and output stage drifts and is gain dependent. The curve of Figure 10 illustrates total input drift over the gain range of 1 to 100V/V.

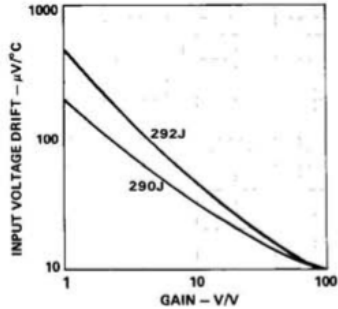
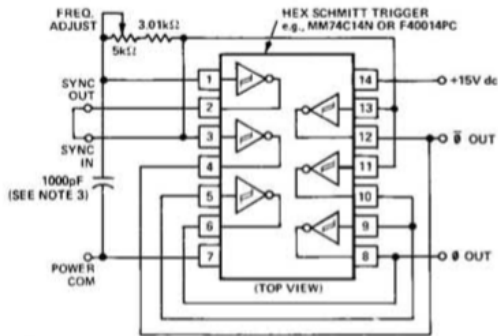

Figure 10. Typical Input Offset Voltage Drift vs. Gain

REFERENCE EXCITATION OSCILLATOR, MODEL 281
When applying model 292A, the user has the option of building a low cost 100kHz excitation oscillator, as shown in Figure 11, or purchasing a module from Analog Devices—model 281.



- NOTES:
 1. FREQ. ADJUST: ADJUST TRIM POT FOR OUTPUT FREQUENCY OF 100kHz ±5%.
 2. FOR SLAVE OPERATION, REMOVE JUMPER FROM SYNC OUT AND SYNC IN PINS.
 3. USE CERAMIC CAPACITOR, "COG" OR "NPO" CHARACTERISTIC.

Figure 11. 100kHz Oscillator Interconnection Diagram

The block diagram of model 281 is shown in Figure 12. An internal +12V dc regulator is provided to permit the user the option of operating over two, pin selectable, power input ranges; terminal 6 offers a range of +14V dc to +28V dc; terminal 7 offers an input range of +8V dc to +14V dc.

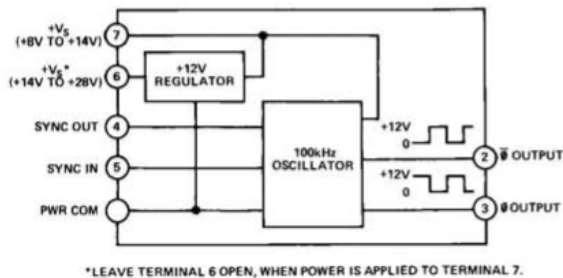

Figure 12. Model 281 Block Diagram

Model 281 oscillator is capable of driving up to 16 model 292A's. As shown in Figure 13, an additional model 281 may be

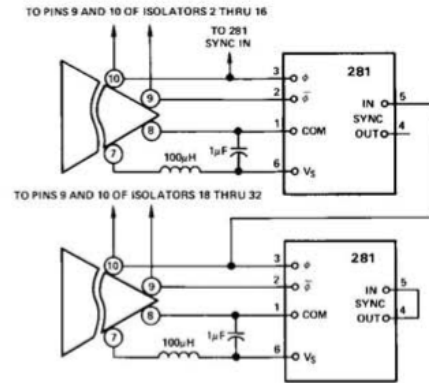

Figure 13. External Oscillator Interconnection

SPECIFICATIONS

(typical @ +25°C and $V_S = +15V$ dc unless otherwise noted)

| MODEL | 281 |
|--|-----------------|
| OUTPUT | |
| Frequency | 100kHz ±5% |
| Waveform | Squarewave |
| Voltage (ϕ and $\bar{\phi}$ terminals) | 0 to +12V pk |
| Fan-Out ^{1,2} | 16 max |
| POWER SUPPLY RANGE³ | |
| High Input, Pin 6 | +(14 to 28)V dc |
| Quiescent Current, N.L. | +5mA |
| F.L. | +16mA |
| Low Input, Pin 7 | +(8 to 14)V dc |
| Quiescent Current, N.L. | +12mA |
| F.L. | +33mA |
| TEMPERATURE | |
| Rated Performance | 0 to +70°C |
| Storage | -55°C to +85°C |

- ¹ Model 292A oscillator drive input represents unity oscillator load.
² For applications requiring more than 16 292A's, additional 281's may be used in a master/slave mode. Refer to Figure 13.
³ Full load consists of 16 model 292A's and 281 oscillator slave.
 Specifications subject to change without notice.

OUTLINE DIMENSIONS

Dimensions shown in inches and (mm).

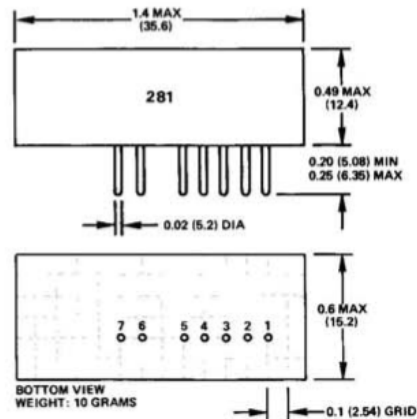

PIN TERMINAL IDENTIFICATION

| | | | |
|---|--------------|---|-------------------------------------|
| 1 | POWER COMMON | 5 | SYNC INPUT |
| 2 | # OUTPUT | 6 | + V_S : HIGH RANGE +14 to 28)V dc |
| 3 | φ OUTPUT | 7 | + V_S : LOW RANGE +8 to 14)V dc |

APPLICATIONS IN INDUSTRIAL MEASUREMENT AND CONTROL SYSTEMS

Remote Sensor Interface: In chemical, nuclear and metal processing industries, models 290A and 292A can be applied to measure and control off-ground millivolt signals in the presence ±1500V dc CMV signals. In interface applications such as pH control systems or on-line process measurement systems such as pollution monitoring, models 290A and 292A offer complete galvanic isolation to eliminate troublesome ground loop problems. Isolated power outputs and adjustable gain add to the application flexibility of these models.

Figure 14 illustrates how model 290A or 292A can be combined with a low drift, 1μV/°C front-end amplifier, model AD517L, to interface low level transducer signals. Both products provide isolated ±13V dc power and front-end guard in addition to eliminating ground loops and preserving high CMR (100dB @ 60Hz).

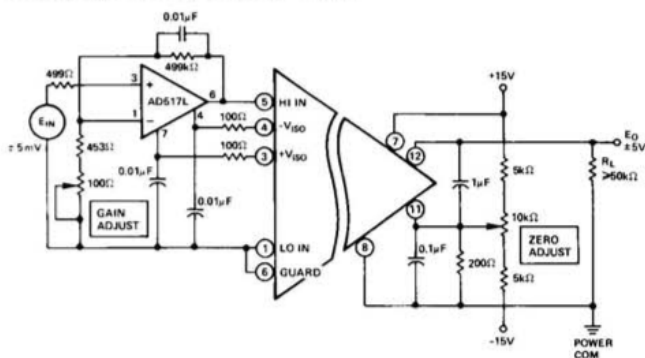

Figure 14. Input Signal Conditioning Using Isolated Power for Transducer Buffer Amplifier

Instrumentation Amplifier: Models 290A and 292A provide a floating guarded input stage capable of directly accepting isolated differential signals. The noninverting, single-ended input stage offers simple two wire interconnection with floating input signals.

In applications where the isolated power is applied to transducers such as bridges which generate differential input signals with common mode voltages measured with respect to the isolated power common, models 290A and 292A can be connected as shown in Figure 15. To achieve high CMR with respect to the ISO PWR COM, the following trim procedure is recommended.

CMR Trim Procedure

- 1) Connect a 1V pk-pk oscillator between the +IN/-IN and IN COM terminals as shown in Figure 15.
- 2) Set the input frequency at 0.5Hz and adjust R1 for minimum Eo.
- 3) Set the input frequency at 60Hz and adjust R2 for minimum Eo.
- 4) Repeat steps 2 and 3 for best CMR performance.

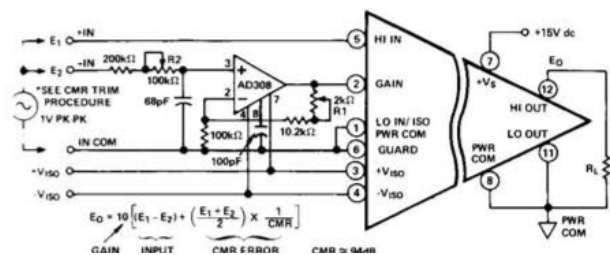

Isolated Temperature Measurements: Industrial temperature measurements are often performed in harsh environments where line voltages or transients can sometimes be impressed on the temperature sensor. To provide protection for the delicate recording instrumentation, models 290A and 292A can be applied as shown in Figure 16. The Analog Devices' AC2626 probe is a temperature sensor whose output is a current directly proportional to absolute temperature. The isolation amplifier provides the isolated power (+13V dc) as well as the input/output isolation. Zero calibration is performed by placing the AC2626 probe in a zero temperature bath and adjusting Ro for Eo to 0 volts. Full scale output adjustment is performed by placing the AC2626 probe in boiling water (100°C) and adjusting Rs for 1.000V output.

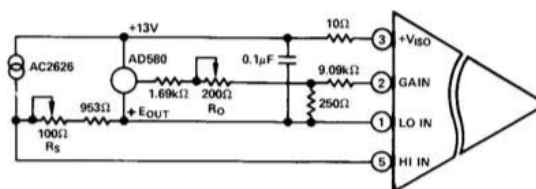

Figure 16. Isolated Temperature Measurements

Current Loop Receiver: Model 290A and 292A can be applied to measurement of analog quantities transmitted via 4-20mA current loops over substantial distances through harsh environments. Figure 17 shows an application of model 290A or 292A as a current loop receiver. A 25Ω resistor converts the 4-20mA current input from a remote loop to a 100-500mV differential voltage input, which the isolator amplifies, isolates, and translates to a 0 to +5V output level at local system ground.

Among the most-helpful characteristics of the isolator in this kind of measurement are the high common-mode rejection (100dB minimum at 60Hz with 1kΩ source unbalance) and the high common-mode rating (±1500 volts dc). The former means low noise pickup; the latter means excellent isolation and protection against large transients. The high common-mode rejection, permitting relatively low input voltage to be used (0.4V span, in this case), permits the use of a low current-metering resistance, which in turn results in low compliance-voltage loading on the current loop, and therefore permits insertion into existing loops without encountering overrange problems. The gain of 12.5 provides a substantial output span, and the floating output permits biasing to a 0 to 5V range.

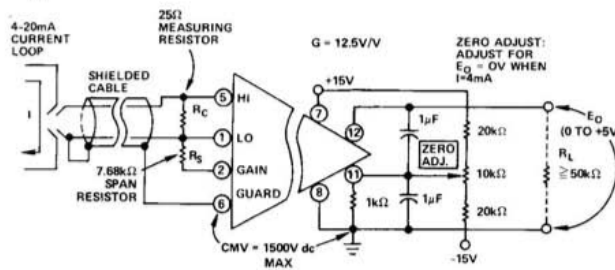

Figure 17. Isolated Analog Interface; 4 to 20mA is Converted to 0 to +5V at the Output, with Up to ±1500V of Isolation

SIGNAL

Figure 15. Application of 290A as Instrumentation Amplifier