

DESCRIPTION

The 1" x 0.1" grid relay series is a general purpose series that is pin-for-pin compatible with most competitor relays. Some configurations of this relay series are capable of switching up to 1000 Volts and up to 2 Amps with a maximum 50 Watt switching. Input/output isolation is as high as 2000 Volt peak for the HRB and MMRB. The series includes Form-A, Form-B and Form-C models, some of which have up to 6 poles.

FEATURES

- Standard nominal voltages include 5, 12 and 24 volts
- Electromagnetic shield
- Multi-pole configurations
- 1.0" x 0.15" pin spacing available
- FCC Part 68 compatible

APPLICATIONS

- Telecom
- Instrumentation
- General purpose electronics
- Industrial
- Process control

RATINGS (@ 25° C)

Parameter	Min	Typ	Max	Unit
Switching Voltage				
HRB			1000	Volts
MMRB			500	Volts
Switching Current				
HRB/MMRB			2	Amps
Carry Current				
HRB/MMRB			3	Amps
Switching Frequency				
HRB/MMRB			200	Hz
Contact Resistance				
HRB			70	mΩ
MMRB			100	mΩ

(See detailed specifications for more information.)

1" x 0.1" GRID RELAYS



HRB ■ MMRB

SPECIFICATIONS

All parameters are at 25°C unless otherwise stated.
Operate voltage, release voltage, and coil resistance will change approximately 0.4%/°C as ambient temperature varies.

PARAMETER	CONDITIONS	SYMBOL	HRB			MMRB			UNITS
			MIN	TYP	MAX	MIN	TYP	MAX	
Contact Ratings									
Switching Voltage	Max DC/PeakAC Resistive	V _L	-	-	1000	-	-	500	Volts
Switching Current	Max DC/PeakAC Resistive	I _L	-	-	2	-	-	2	Amps
Carry Current	Max DC/PeakAC Resistive	I _c	-	-	3	-	-	3	Amps
Contact Rating	Max DC/PeakAC Resistive	-	-	-	50	-	-	50	Watts
Life Expectancy	Signal Level 1.0V 10mA	-	1000	2000	-	200	300	-	x10 ⁶ Ops
	Rated Loads ⁽¹⁾	-	-	-	-	-	-	-	x10 ⁶ Ops
Static Contact Resistance	50mV, 10mA	CR	-	-	70	-	-	100	mΩ
Dynamic Contact Resistance	.5V, 50mA at 100Hz, 1.5 msec	DCR	-	N/A	-	-	N/A	-	mΩ
Contact Material		-	-	Hg	-	-	Hg	-	-
Hg Content		-	-	40	-	-	16	-	mgrams
Relay Specifications									
Insulation Resistance	Between all isolated pins at 100V, 25°C, 40% RH	IR	10 ⁸	-	-	10 ⁸	10 ¹⁰	-	Ω
Capacitance		-	-	-	0.6	-	-	1.5	p
Across Open Contacts		-	-	-	4	-	-	2.5	pF
Open Contact to Coil		-	-	-	-	-	-	-	-
Dielectric Strength	Between Contacts	-	2000	-	-	2000	-	-	VDC/PeakAC
	Contacts to Coil	I/O	1400	-	-	1400	-	-	VDC/PeakAC
Operate Time, no bounce	At Nominal Coil Voltage	T _{OP}	-	-	-	-	-	-	ms
Release Time	10Hz Square Wave	-	-	-	3.00	-	1.6	2.70	-
	Zener-Diode Suppression	T _{REL}	-	-	2.00	-	1.4	1.75	ms
Environmental Ratings									
Storage Temperature		T _A	-40	-	+105	-40	-	+105	°C
Operating Temperature		T _O	-38	-	+85	-38	-	+75	°C
Soldering Temperature	Applied to pins, 5 sec. max.	-	-	-	+260	-	-	+260	°C
Vibration Resistance (Survival)	10Hz - 500Hz	G	-	-	10	-	-	10	Gs
Shock Resistance (Survival)	11±1ms, 1/2 Sine Wave	S	-	-	30	-	-	30	Gs
Weight		-	-	5.1	-	-	5.3	-	grams

(1) For further information, consult factory

(2) Relay must be mounted vertically. Pin 1 is up.

COIL SPECIFICATIONS

Part #	Coil Voltage			Coil Resistance			Operate Voltage			Release Voltage			Nominal Input Power		
	Units	Volts			Ω			Volts			Volts			mW	
Conditions				+/- 10% (25°C)			Must operate by (25°C)			Must release by (25°C)					
	Min	Typ	Max	Min	Typ	Max	Min	Typ	Max	Min	Typ	Max	Min	Typ	Max
HRB1A05		5	12	180	200	220			3.75	0.15					125
HRB1A12		12	26	837	930	1023			9	0.7					155
HRB1A24		24	53	3348	3720	4092			18	1.4					155
HRB2A05		5	9	90	100	110			3.75	0.15					250
HRB2A12		12	23	607.5	675	742.5			9	0.7					213
HRB2A24		24	45	2232	2480	2728			18	1.4					232
HRB3A05		5	8	72	80	88			3.75	0.15					313
HRB3A12		12	18	338	375	413			9	0.7					384
HRB3A24		24	36	1350	1500	1650			18	1.4					384
HRB4A05		5	8	54	60	66			3.75	0.15					417
HRB4A12		12	18	315	350	385			9	0.7					411
HRB4A24		24	31	900	1000	1100			18	1.4					576
HRB5A05		5	7	41	45	50			3.75	0.15					556
HRB5A12		12	17	252	280	308			9	0.7					514
HRB5A24		24	30	828	920	1012			18	1.4					626
HRB6A05		5	7	36	40	44			3.75	0.15					625
HRB6A12		12	15	189	210	231			9	0.7					686
HRB6A24		24	31	792	880	968			18	1.4					655
MMRB1A05		5	12	180	200	220			3.75	0.15					125
MMRB1A12		12	26	837	930	1023			9	0.7					155
MMRB1A24		24	53	3348	3720	4092			18	1.4					155
MMRB2A05		5	9	90	100	110			3.75	0.15					250
MMRB2A12		12	23	608	675	743			9	0.7					213
MMRB2A24		24	45	2232	2480	2728			18	1.4					232
MMRB3A05		5	8	72	80	88			3.75	0.15					313
MMRB3A12		12	18	338	375	413			9	0.7					384
MMRB3A24		24	36	1350	1500	1650			18	1.4					384
MMRB4A05		5	8	54	60	66			3.75	0.15					417
MMRB4A12		12	18	315	350	385			9	0.7					411
MMRB4A24		24	31	900	1000	1100			18	1.4					576
MMRB5A05		5	7	41	45	50			3.75	0.15					556
MMRB5A12		12	17	252	280	308			9	0.7					514
MMRB5A24		24	30	828	920	1012			18	1.4					626
MMRB6A05		5	7	36	40	44			3.75	0.15					625
MMRB6A12		12	15	189	210	231			9	0.7					686
MMRB6A24		24	31	792	880	968			18	1.4					655

1" x 0.1" GRID RELAYS

HRB ■ MMRB



MECHANICAL DIMENSIONS

DIMENSIONS
mm
(inches)

1.0 x 0.1 1A

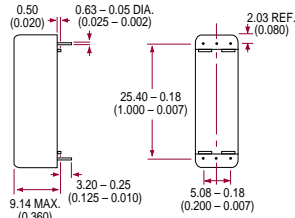
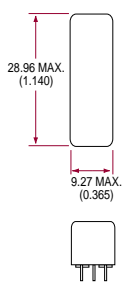

1.0 x .15 1A

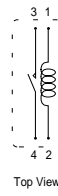

.0 x 0.1 2A/1C/1B/1L

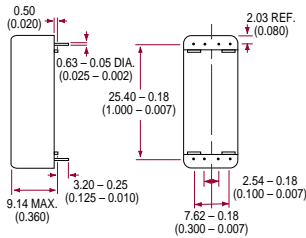
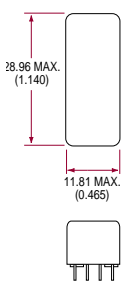

.0 x 0.1 2A

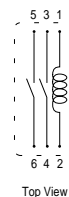

.0 x 0.1 1B

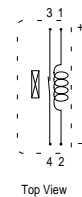

.0 x 0.1 1C

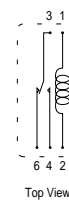

.0 x 0.1 1L

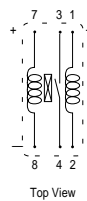

1.0 x 0.1 3A/2B/1N/2L/2C

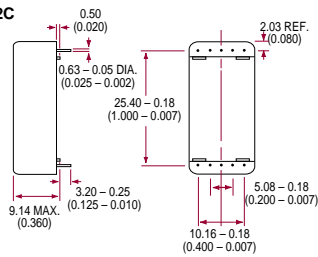
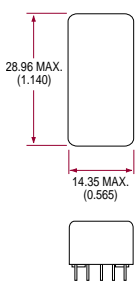

.0 x 0.1 3A

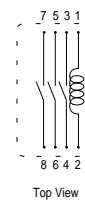

.0 x 0.1 2B

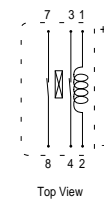

1.0 x 0.1 2C

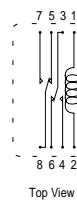

1.0 x 0.1 1N

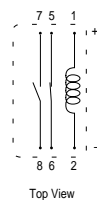

1.0 x 0.1 2L

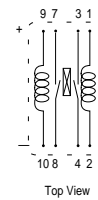

Note: HRB must be mounted vertically. Pin 1 is up.

MECHANICAL DIMENSIONS

DIMENSIONS
mm
(inches)

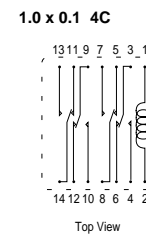
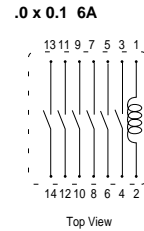
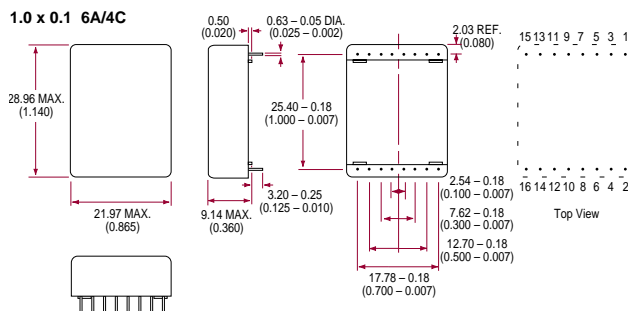
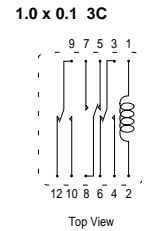
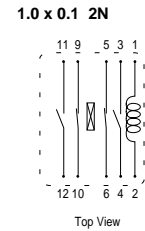
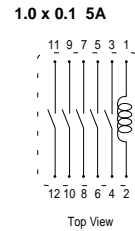
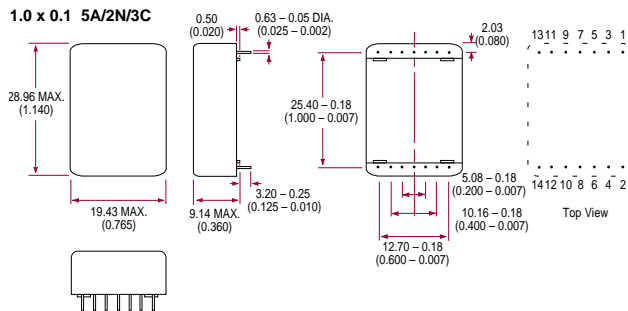
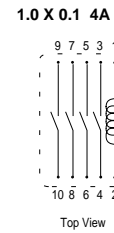
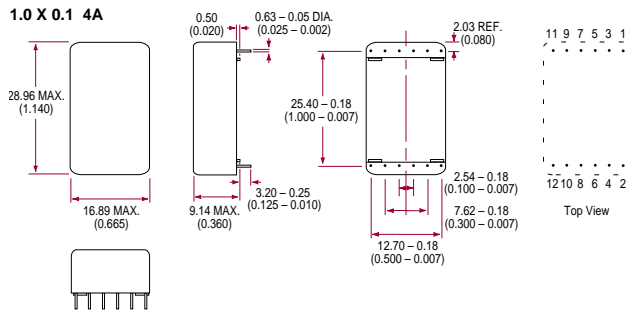

Note: HRB must be mounted vertically. Pin 1 is up.

1" x 0.1" GRID RELAYS

HRB ■ MMRB



MECHANICAL DIMENSIONS

DIMENSIONS
mm
(inches)

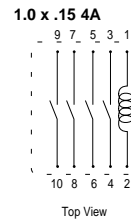
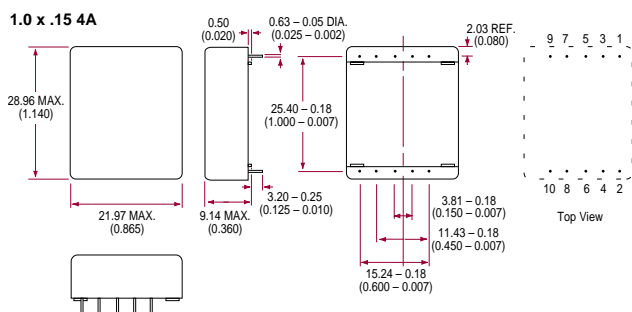
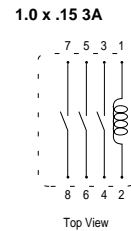
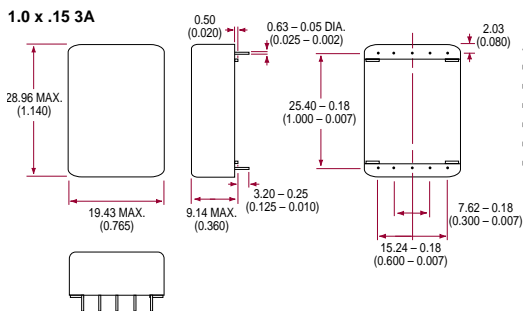
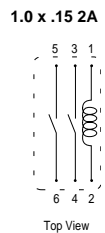
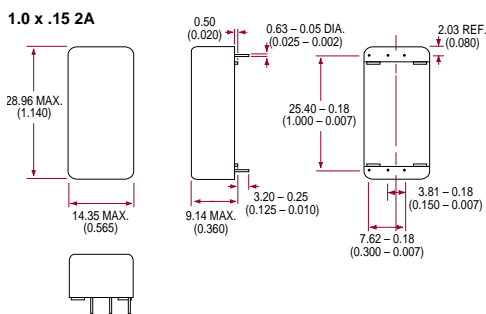
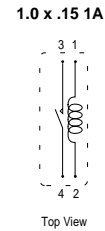
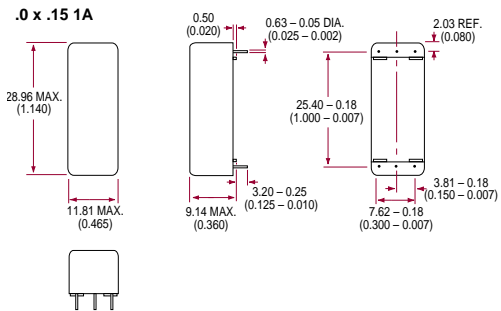

Note: HRB must be mounted vertically. Pin 1 is up.

ORDERING INFORMATION

A complete part number is represented by the digits below.

