

**TELEDYNE
RELAYS**

A Teledyne Technologies Company

**BROADBAND
HIGH REPEATABILITY
TO-5 RELAY
SPDT
DC-8 GHz**

**SERIES
RF311
RF331**

SERIES DESIGNATION	RELAY TYPE
RF311	SPDT RF TO-5 relay
RF331	Sensitive, SPDT RF TO-5 relay

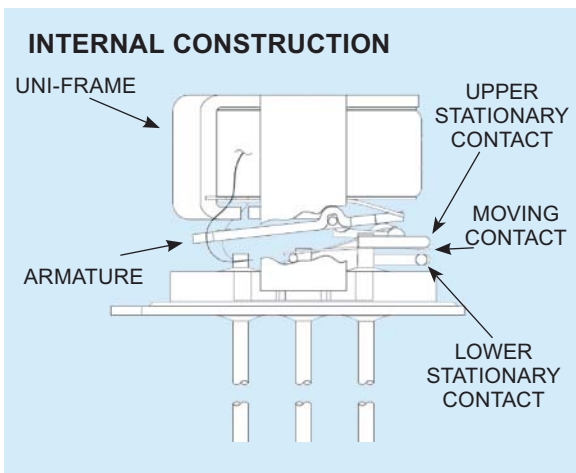

PERFORMANCE FEATURES

The ultraminiature RF311 and RF331 relays are designed to provide improved RF signal repeatability over the frequency range. These relays are highly suitable for use in attenuator and other RF circuits. The RF311 and RF331 feature:

- High repeatability.
- Exceptional bandwidth.
- Metal enclosure for EMI shielding.
- Ground pin option to improve case grounding.
- High isolation between control and signal paths.
- Highly resistant to ESD.

ENVIRONMENTAL AND PHYSICAL SPECIFICATIONS		
Temperature (Ambient)	Storage	-65°C to +125°C
	Operating	-55°C to +85°C
Vibration (General Note 1)		10 g's to 500 Hz
Shock (General Note 1)		30 g's, 6ms half sine
Enclosure		Hermetically sealed
Weight	RF311	0.089 oz. (2.52g) max.
	RF331	0.109 oz. (3.09g) max.

CONSTRUCTION FEATURES

The following unique construction features and manufacturing techniques provide excellent resistance to environmental extremes and overall high reliability:

- Uni-frame motor design provides high magnetic efficiency and mechanical rigidity.
- Minimum mass components and welded construction provide maximum resistance to shock and vibration.
- Advanced cleaning techniques provide maximum assurance of internal cleanliness.
- Gold-plated precious metal alloy contacts ensure reliable switching.
- Hermetically sealed.
- RoHS compliant.

**SERIES RF311 AND RF331
GENERAL ELECTRICAL SPECIFICATIONS (@25°C unless otherwise noted) (Notes 2 & 3)**

Contact Arrangement	1 Form C (SPDT)
Rated Duty	Continuous
Contact Resistance	0.15 Ω max. initial (measured 1/8" (3.2mm) from header)
Contact Load Ratings (DC)	Resistive: 1A @ 28V dc Low level: 10 to 50 μA @ 10 to 50 mV
Contact Life Ratings	10,000,000 cycles (typical) at low level
Coil Operating Power	RF311: 350 mW typical @ nominal rated voltage RF331: 185 mW typical @ nominal rated voltage
Operate Time	RF311: 4.0 mS max. RF331: 6.0 mS max.
Release Time	RF311: 3.0 mS max. RF331: 3.0 mS max.
Intercontact Capacitance	0.4 pf typical
Insulation Resistance	1,000 MΩ min. between mutually isolated terminals
Dielectric Strength	Atmospheric pressure: 350 Vrms (60 Hz)

DETAILED ELECTRICAL SPECIFICATIONS (@25°C)

BASE PART NUMBERS		RF311-5/RF331-5	RF311-12/RF331-12	RF311-26/RF331-26
Coil Voltage (Vdc)	Nom.	5.0	12.0	26.5
Coil Resistance (Ohms ±20%)	RF311	63	500	2000
	RF331	125	1025	4000
Pick-up Voltage (Vdc max.)	RF311	3.6	9.0	18.0
	RF331	3.6	9.0	18.0

OUTLINE DIMENSIONS

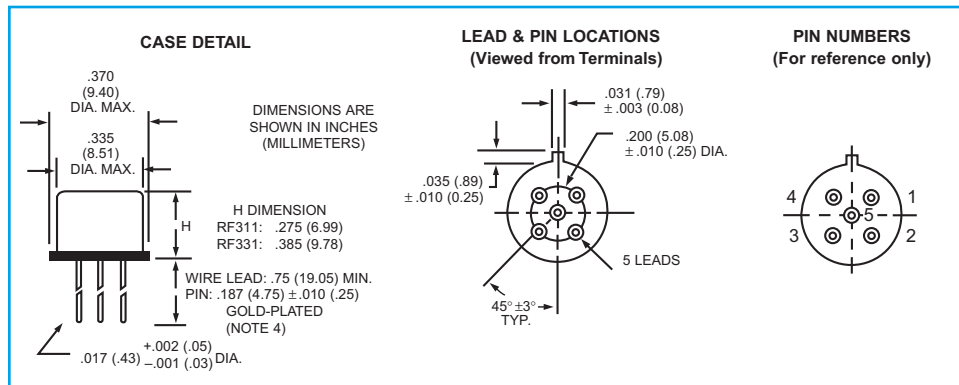

SCHEMATIC DIAGRAM (TERMINAL VIEW)

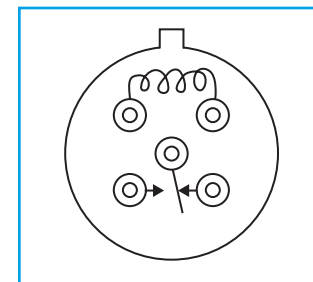

GENERAL NOTES

1. Relay contacts will exhibit no chatter in excess of 10 μsec or transfer in excess of 1 μsec.
2. "Typical" characteristics are based on available data and are best estimates. No on-going verification tests are performed.
3. Unless otherwise specified, parameters are initial values.
4. Leads are 0.75" standard. To order 0.187" leads, add /S to the base part number.
Ex. RF311-5/S.

**SERIES RF311 AND RF331
TYPICAL RF CHARACTERISTICS**

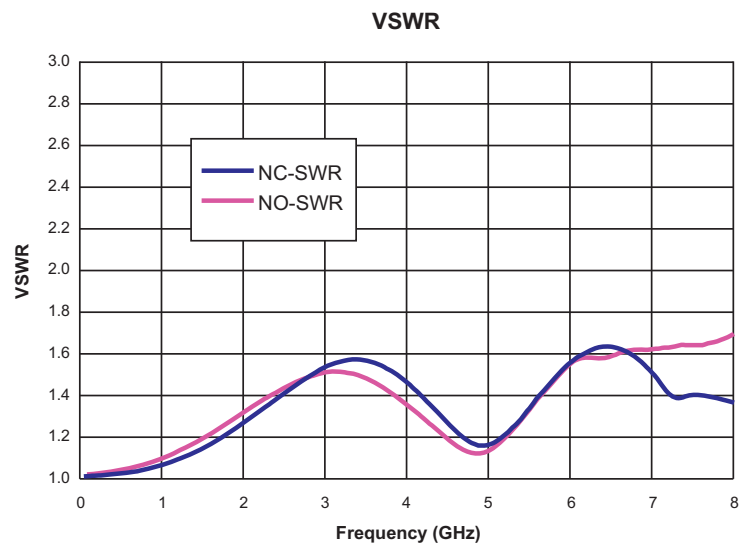
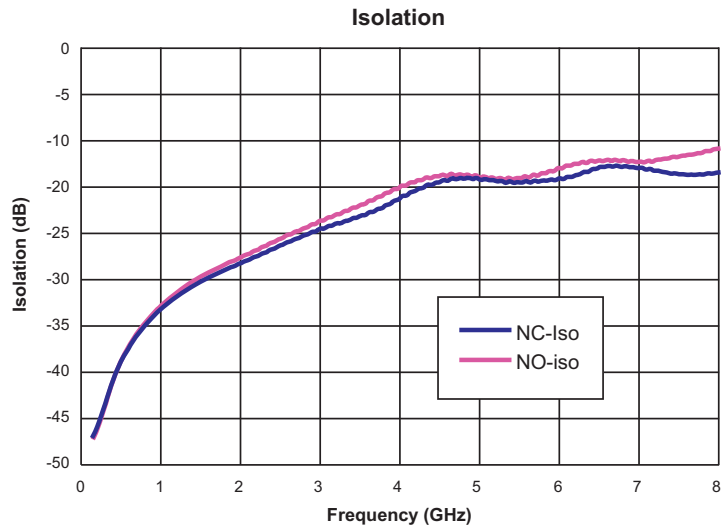
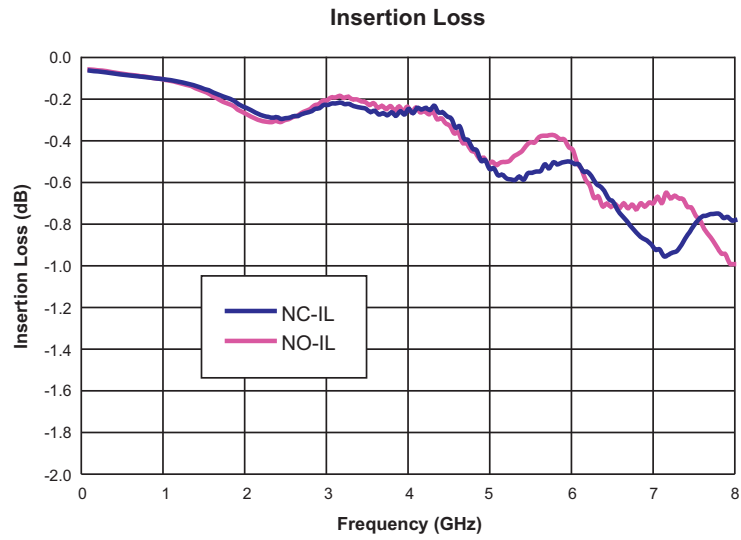

**SERIES RF311 AND RF331
TYPICAL RF CHARACTERISTICS**

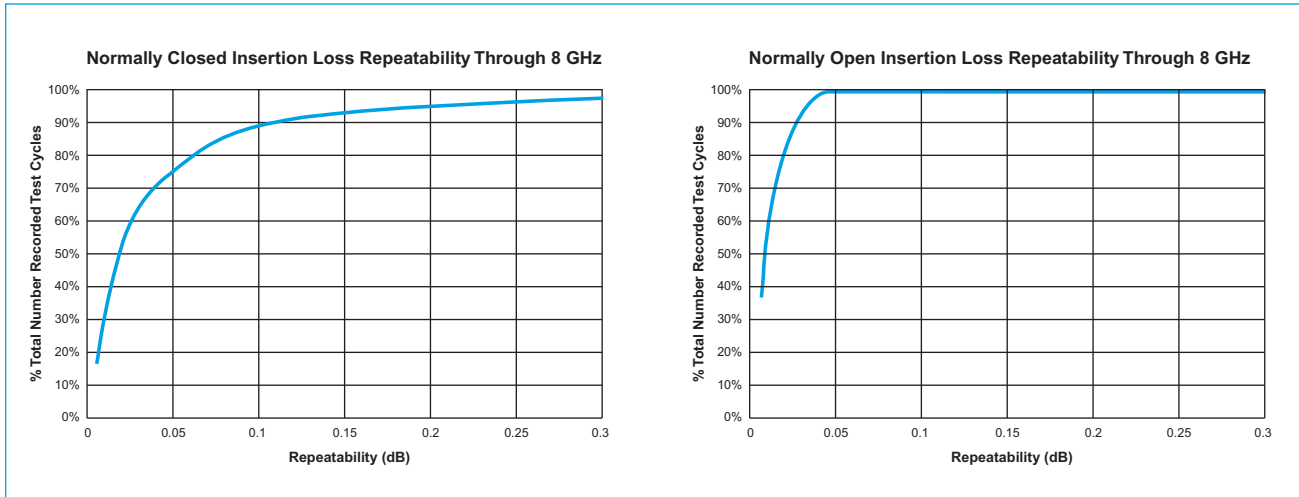

**SERIES RF311 AND RF331
TYPICAL TIME DOMAIN CHARACTERISTICS**

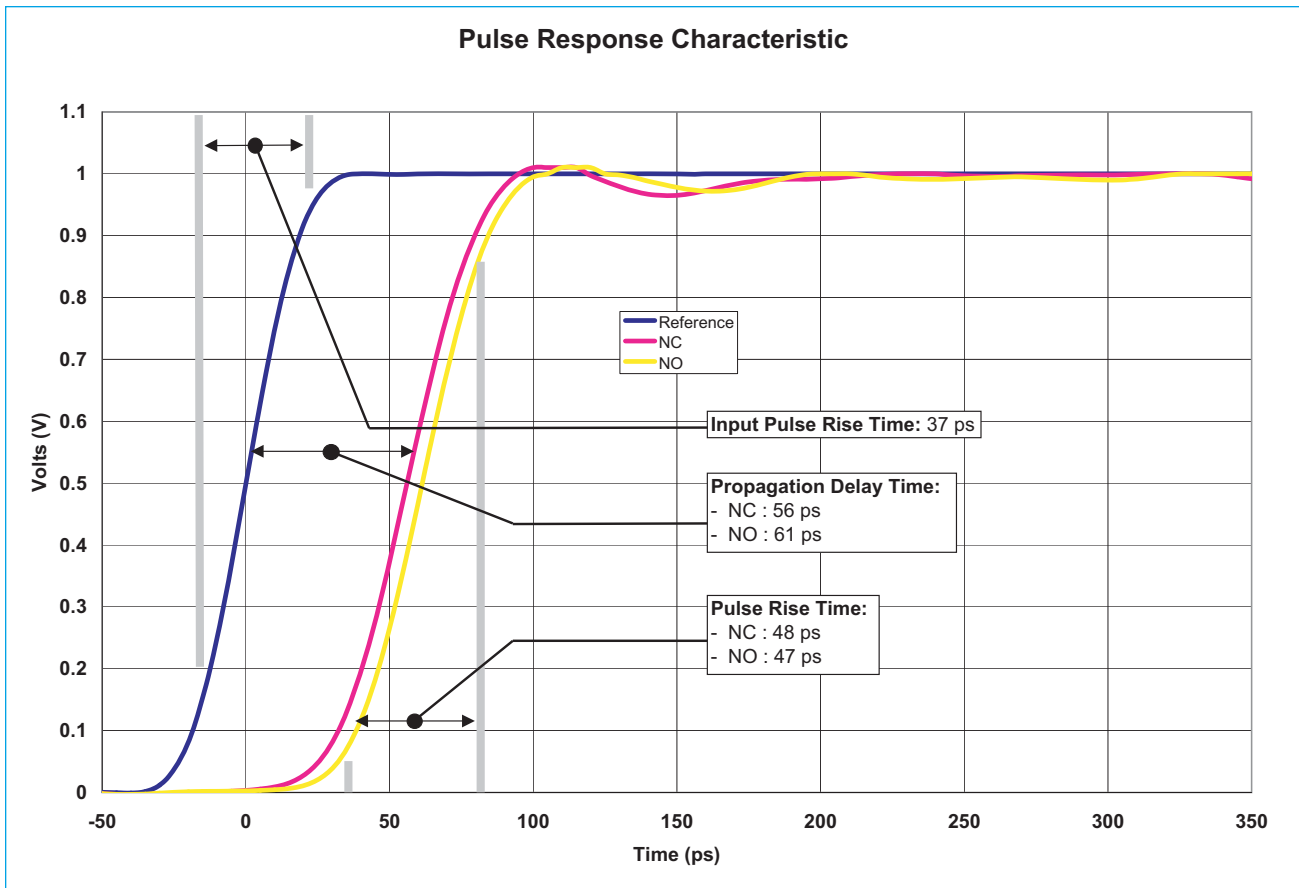

**SERIES RF311 AND RF331
SMITH CHARTS**

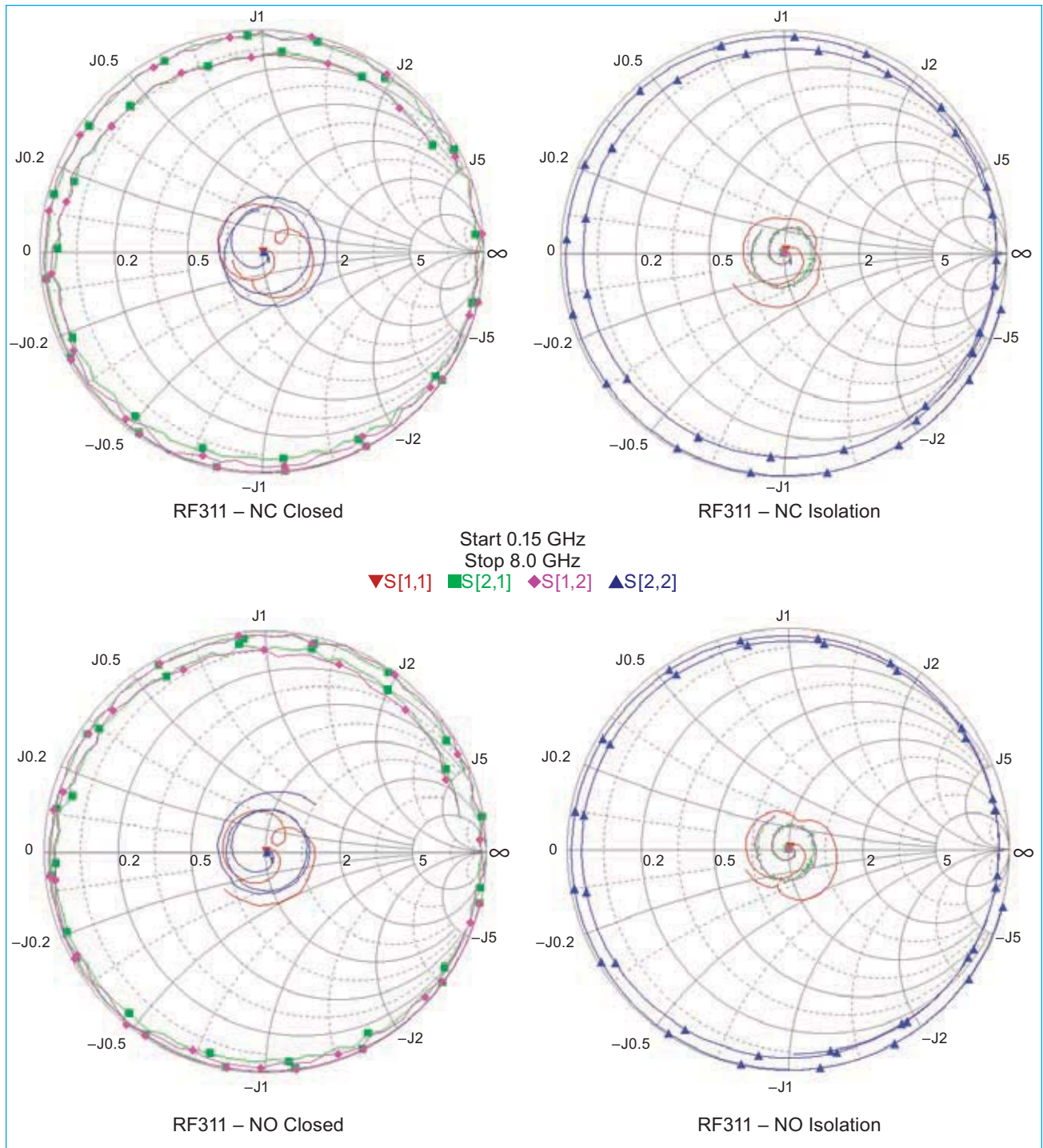

RF NOTES

Relay part number[s]: RF311-5, lot 06377E0830
 Frequency range: 0.15 GHz to 8.0 GHz [1]
 Test signal level: -10 dBm
 Test apparatus: Vector Network Analyzer HP8722D
 Test temperature: Room ambient

Number of samples: 2 (except Smith Charts is 1 sample only)
 Number of test points: 201
 Data includes effect of test fixture: No
 Mounting: Relays through hole mounted to RF PCB. Relay in contact with, but not soldered to, Ground. [Note 1]

NOTES: [a] RF PCB: 0.0031" copper clad, reinforced PTFE, RT/duroid® 5880 with SMA connectors
 (RT/duroid® is registered trademark of Rogers Corporation)

[b] During test, untested port is terminated with 50 Ω terminator

[c] Data herein are typical values based on the samples tested. Not for use as specification requirements.

Appendix A: Spacer Pads

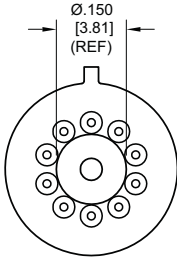
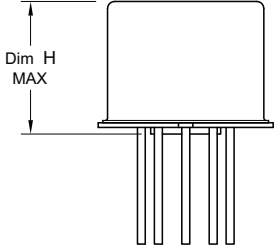
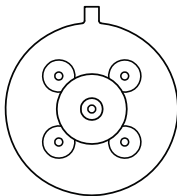
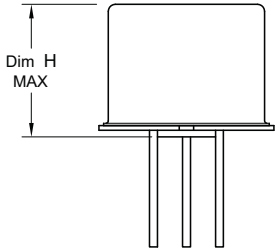
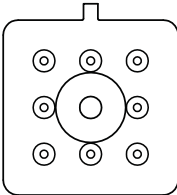
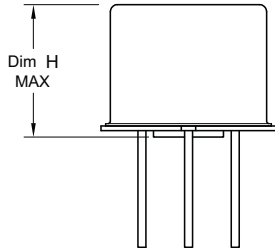
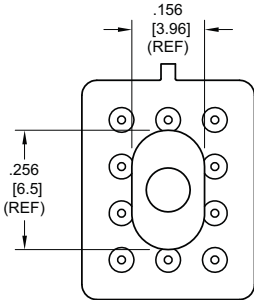
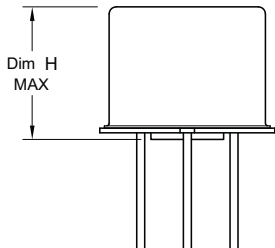
Pad designation and bottom view dimensions	Height	For use with the following:	Dim. H Max.
 <p style="text-align: center;">“M4” Pad for TO-5</p>		ER411T ER412, ER412D, ER412DD	.295 (7.49)
		712, 712D, 712TN, RF300, RF310, RF320	.300 (7.62)
		ER420, ER422D, ER420DD, 421, ER421D, ER421DD, ER422, ER422D, ER422DD, 722, 722D, RF341	.305 (7.75)
		ER431T, ER432T, ER432, ER432D, ER432DD	.400 (10.16)
		732, 732D, 732TN, RF303, RF313, RF323	.410 (10.41)
		RF312	.350 (8.89)
 <p style="text-align: center;">“M4” Pad for TO-5</p>		ER411, ER411D, ER411DD	.295 (7.49)
		ER431, ER431D, ER431DD	.400 (10.16)
		RF311	.300 (7.62)
		RF331	.410 (10.41)
 <p style="text-align: center;">“M4” Pad for Centigrid®</p>		172, 172D	.305 (7.75)
		ER114, ER114D, ER114DD, J114, J114D, J114DD	.300 (7.62)
		ER134, ER134D, ER134DD, J134, J134D, J134DD	.400 (10.16)
		RF100	.315 (8.00)
		RF103	.420 (10.67)
 <p style="text-align: center;">“M9” Pad for Centigrid®</p>		122C, A152	.320 (8.13)
		ER116C, J116C	.300 (7.62)
		ER136C, J136C	.400 (10.16)
		RF180	.325 (8.25)
		A150	.305 (7.75)

Notes:

1. Spacer pad material: Polyester film.
2. To specify an “M4” or “M9” spacer pad, refer to the mounting variants portion of the part numbering example in the applicable datasheet.
3. Dimensions are in inches (mm).
4. Unless otherwise specified, tolerance is $\pm .010$ (.25).
5. Add 10 m Ω to the contact resistance show in the datasheet.
6. Add 0.01 oz. (0.25 g) to the weight of the relay assembly shown in the datasheet.

Appendix A: Spreader Pads

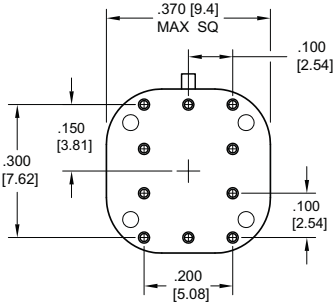
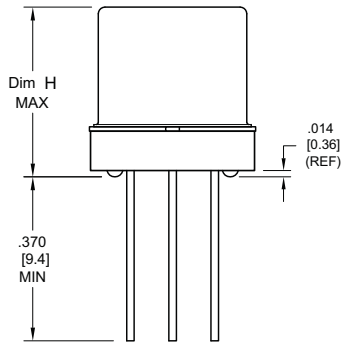
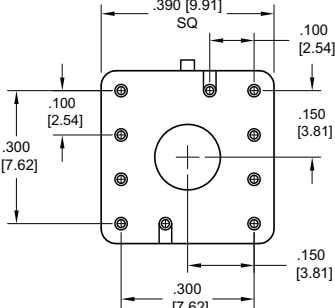
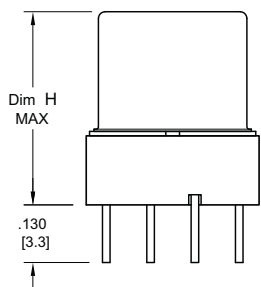
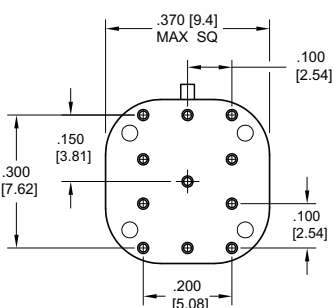
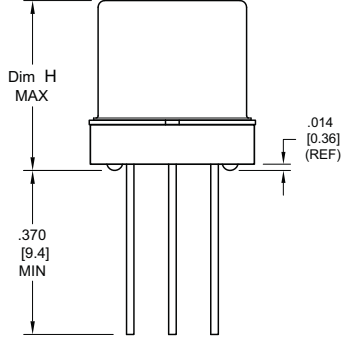
Pad designation and bottom view dimensions	Height	For use with the following:	Dim. H Max.
 <p>“M” Pad <u>5/</u> <u>6/</u></p>		ER411T, J411T, ER412, ER412D ER412DD, J412, J412D, J412DD ER412T, J412T	.388 (9.86)
		712, 712D, 712TN	.393 (9.99)
		ER431T, J431T, ER432, ER432D ER432DD, J432, J432D, J432DD ER432T, J432T	.493 (12.52)
		732, 732D, 732TN	.503 (12.78)
		ER420, J420, ER420D, J420D ER420DD, J420DD, ER421, J421 ER421D, J421D, ER421DD J422D, ER422DD, J422DD, 722	.398 (10.11)
 <p>“M2” Pad <u>7/</u> <u>8/</u></p>		ER411T ER412, ER412D, ER412DD J412, J412D, J412DD	.441 (11.20)
		712, 712D	.451 (11.46)
		ER421, ER421D, ER421DD 722, 732D	.451 (11.46)
		ER431T ER432, ER432D, ER432DD	.546 (13.87)
		732, 732D	.556 (14.12)
 <p>“M3” Pad <u>5/</u> <u>6/</u> <u>9/</u></p>		ER411, ER411D, ER411DD ER411TX ER412X, ER412DX, ER412DDX ER412TX	.388 (9.86)
		712X, 712DX, 712TNX	.393 (9.99)
		ER420X, ER420DX, ER420DDX ER421X, ER421DX, ER421DDX ER422X, ER422DX ER422DDX, 722X, 722DDX	.398 (10.11)
		ER431, ER431D, ER431DD ER431TX ER432X, ER432DX, ER432DDX ER432TX	.493 (12.52)
		732X, 732DX, 732TNX	.503 (12.78)

Notes:

1. Spreader pad material: Diallyl Phthalate.
2. To specify an “M”, “M2” or “M3” spreader pad, refer to the mounting variants portion of the part number example in the applicable datasheet.
3. Dimensions are in inches (mm).
4. Unless otherwise specified, tolerance is $\pm .010$ ” (0.25).
- 5/. Add 25 mΩ to the contact resistance shown in the datasheet.
- 6/. Add .01 oz. (0.25 g) to the weight of the relay assembly shown in the datasheet.
- 7/. Add 50 mΩ to the contact resistance shown in the datasheet.
- 8/. Add 0.025 oz (0.71 g) to the weight of the relay assembly shown in the datasheet.
- 9/. M3 pad to be used only when the relay has a center pin (e.g. ER411M3-12A, 722XM3-26.)

Appendix A: Ground Pin Positions

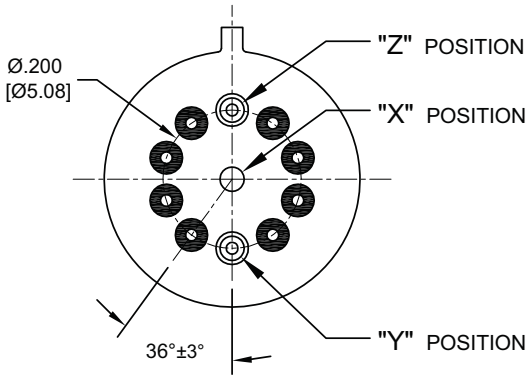

TO-5 Relays:

ER411T, ER412, ER412T, ER420, ER421, ER422,
ER431T, ER432, ER432T, 712, 712TN, 400H, 400K,
400V, RF300, RF303, RF341, RF312, RF310, RF313,
RF320, RF323

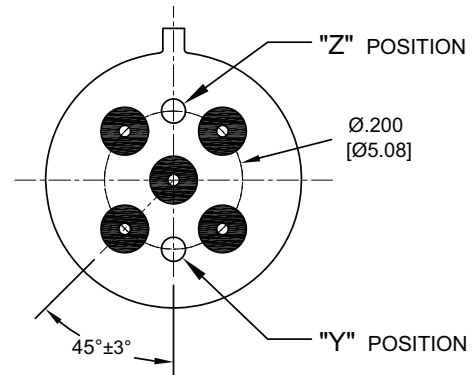

TO-5 Relays:

ER411, ER431, RF311, RF331

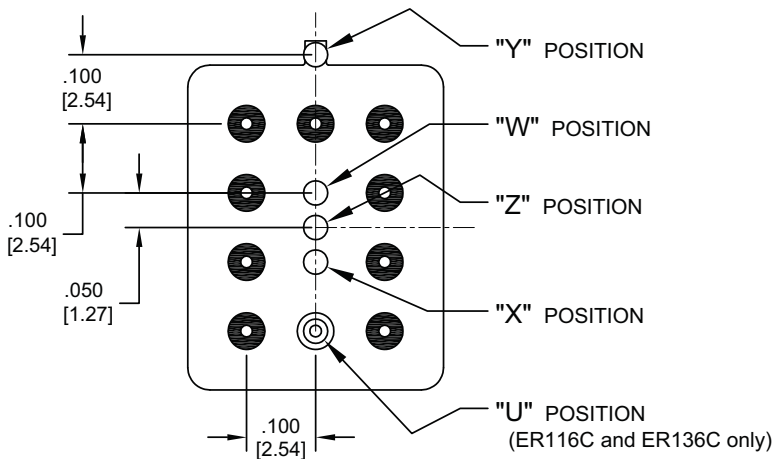

Centigrid® Relays:

RF180, ER116C, 122C, ER136C

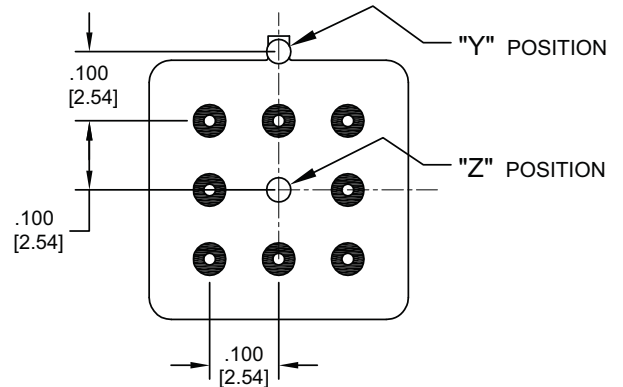

Centigrid® Relays:

RF100, RF103, ER114, ER134, 172

- Indicates ground pin position
- Indicates glass insulated lead position
- ◎ Indicates ground pin or lead position depending on relay type

NOTES

1. Terminal views shown
2. Dimensions are in inches (mm)
3. Tolerances: $\pm .010$ ($\pm .25$) unless otherwise specified
4. Ground pin positions are within $.015$ (0.38) dia. of true position
5. Ground pin head dia., 0.035 (0.89) ref: height 0.010 (0.25) ref.
6. Lead dia. 0.017 (0.43) nom.