



**HIGH REPEATABILITY,
DC-8 GHz/20Gbps
TO-5 RELAYS, DPDT**

SERIES	RELAY TYPE
RF312	Repeatable, RF relay
RF332	Low Power Operating Coil, RF relay

DESCRIPTION

The ultra miniature RF312 is designed to improve upon the RF300/RF303 relay's high frequency performance. The RF312/RF332 offers monotonic insertion loss to 8 GHz. This improvement in RF insertion loss over the frequency range, makes these relays highly suitable for use in attenuator and other RF circuits. The sensitive RF332 relay has a high resistance coil, thus requiring extremely low operating power (200 mW typical).

The RF312/RF332 features:

- High repeatability.
- Broader bandwidth.
- Metal enclosure for EMI shielding.
- Ground pin option to improve case grounding.
- High isolation between control and signal paths.
- Highly resistant to ESD.

CONSTRUCTION FEATURES

The following unique construction features and manufacturing techniques provide excellent resistance to environmental extremes and overall reliability.

- Uni-frame motor design provides high magnetic efficiency and mechanical rigidity.
- Minimum mass components and welded construction provide maximum resistance to shock and vibration.
- Advanced cleaning techniques provide maximum assurance of internal cleanliness.
- Gold-plated precious metal alloy contacts ensure reliable switching and signal fidelity.
- Hermetically sealed.
- Solder-Dipped Leads, (RoHS compliant solder option available)

ENVIRONMENTAL AND PHYSICAL SPECIFICATIONS		
Temperature (Ambient)	Storage	-65°C to +125°C
	Operating	-55°C to +85°C
Vibration (General Note I)	10 g's to 500 Hz	
Shock (General Note I)	30 g's, 6ms half sine	
Enclosure	Hermetically sealed	
Weight	0.09 oz. (2.55g) max.	

SERIES RF312/RF332
TYPICAL RF CHARACTERISTICS (See RF Notes)

Isolation Across Contacts (RF Note 4)

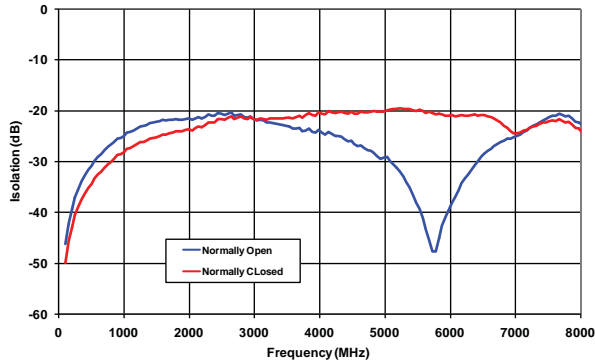

Isolation Pole to Pole (RF Note 5)

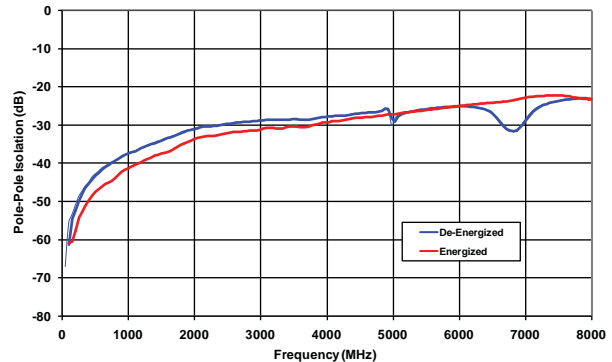

Insertion Loss (RF Note 6)

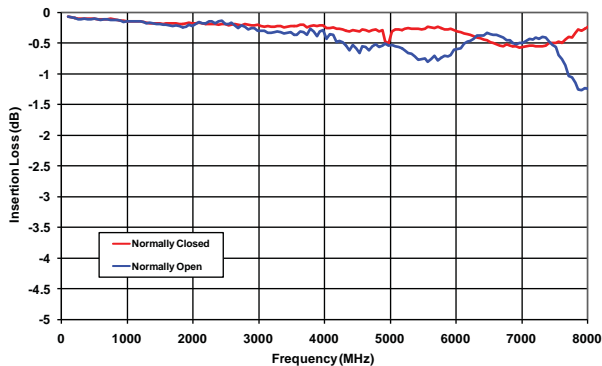

VSWR (RF Note 6)

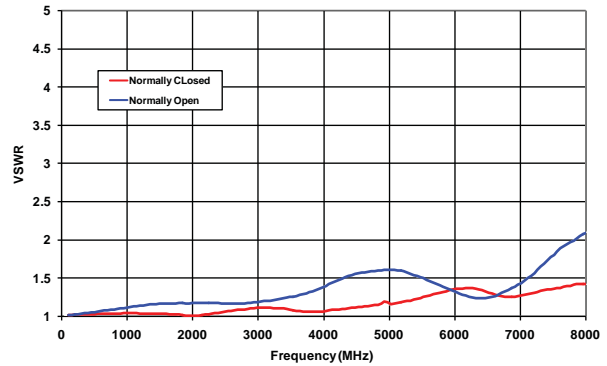

RF312/RF332 Time Response (RF Note 6)

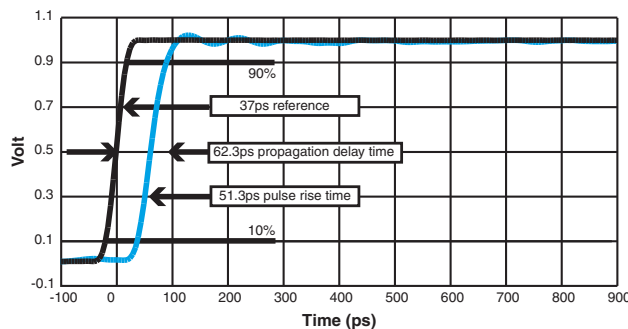

RF NOTES

1. Test conditions:
 - a. Fixture: .031" copper clad, reinforced PTFE, RT/duroid® 6002 with SMA connectors. (RT/duroid® is a registered trademark of Rogers Corporation.)
 - b. Room ambient temperature.
 - c. Terminals not tested were terminated with 50-ohm load.
 - d. Contact signal level: -10 dBm.
 - e. No. of test samples: 4.
2. Data presented herein represents typical characteristics and is not intended for use as specification limits.
3. Data is per pole, except for pole-to-pole data.
4. Data is the average from readings taken on all open contacts.
5. Data is the average from readings taken on poles with coil energized and de-energized.
6. Data is the average from readings taken on all closed contacts.
7. Test fixture effect de-embedded from frequency and time response data.



**SERIES RF312/RF332
GENERAL ELECTRICAL SPECIFICATIONS (@25°C)**

Contact Arrangement	2 Form C (DPDT)
Rated Duty	Continuous
Contact Resistance	0.15 Ω max.
Contact Load Rating	Resistive: 1Amp/28Vdc Low level: 10 to 50 μA @ 10 to 50 mV
Contact Life Ratings	1,000,000 cycles (typical) at low level contact load
Coil Operating Power	RF312: 450 mW typical at nominal rated voltage RF332: 200 mW typical at nominal rated voltage
Operate Time	RF312: 4.0 mS max. RF332: 6.0 mS max.
Release Time	3.0 mS max.
Intercontact Capacitance	0.4 pf typical
Insulation Resistance	1,000 MΩ min. between mutually isolated terminals
Dielectric Strength	350 Vrms (60 Hz) @ atmospheric pressure

DETAILED ELECTRICAL SPECIFICATIONS (@25°C)

BASE PART NUMBERS (RF312)	RF312-5	RF312-12
Coil Voltage, Nominal (Vdc)	5.0	12.0
Coil Resistance (Ohms ±20%)	50	390
Pick-up Voltage (Vdc max.)	3.6	9.0

BASE PART NUMBERS (RF332)	RF332-5	RF332-12
Coil Voltage, Nominal (Vdc)	5.0	12.0
Coil Resistance (Ohms ±20%)	100	850
Pick-up Voltage (Vdc max.)	3.6	9.0

Teledyne Part Numbering System for RF312/RF332

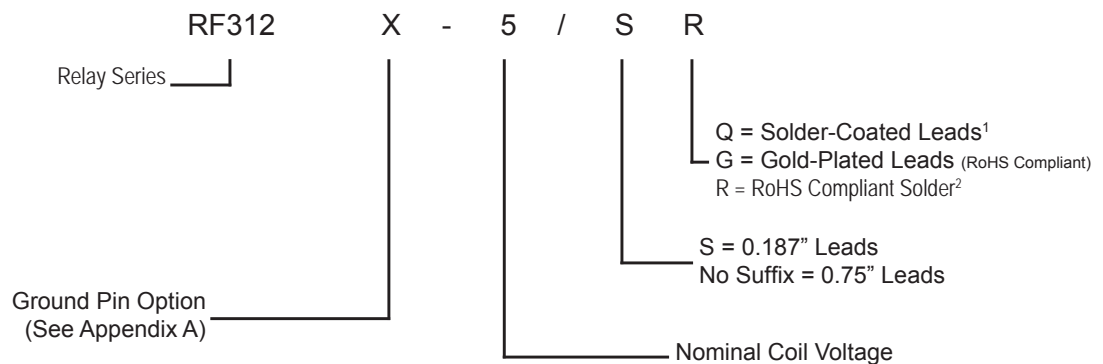

General Note: Parts ordered without suffix may be supplied with Solder-Coated or Gold-Plated leads

¹ Parts ordered with Solder-Coated leads will have (Sn60/Pb40)

² Parts ordered with RoHS Solder-Coated leads will have (Sn99.3/Cu0.7)

**SERIES RF312/RF332
OUTLINE DIMENSIONS**

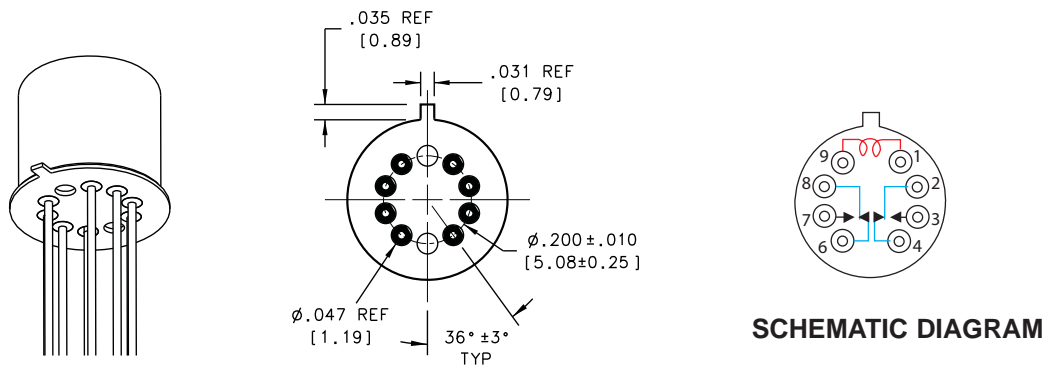
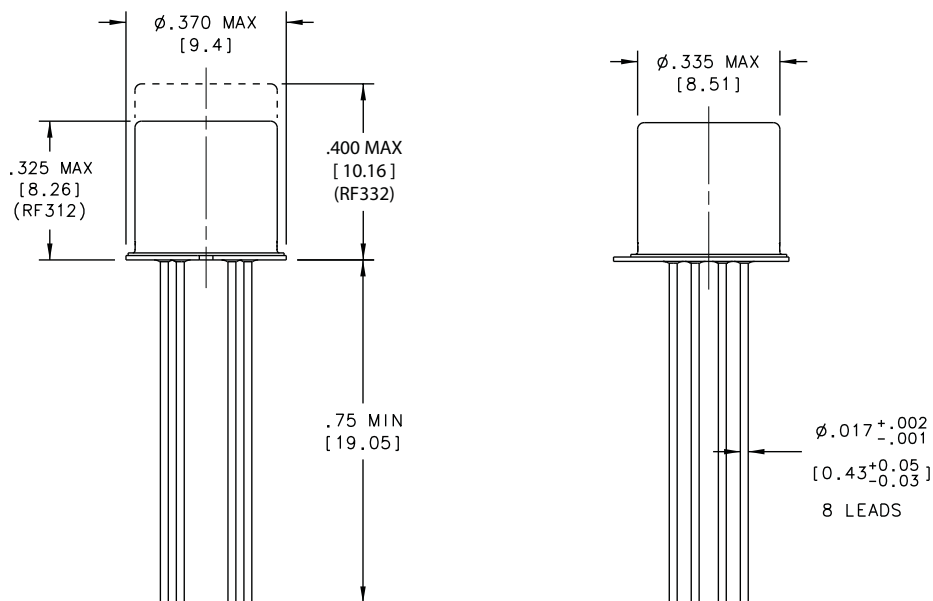

NOTES:

1. DIMENSIONS ARE IN INCHES, METRIC EQUIVALENTS SHOWN IN [].
2. POSITIONS 5 AND 10 ARE FOR UNINSULATED CASE GROUND OPTIONS.
3. NO PROTRUSION BELOW BOTTOM OF HEADER WHEN GROUND PINS ARE INSTALLED
4. TO ORDER THE CASE GROUND OPTION, AFTER THE SERIES DESIGNATOR, ADD "Y" TO THE PART NUMBER FOR POSITION 5 OR "Z" TO THE PART NUMBER FOR POSITION 10.

GENERAL NOTES

- I. Relays will exhibit no contact chatter in excess of 10 μsec or transfer in excess of 1 μsec .
- II. For reference only. Coil resistance not directly measurable at relay terminals due to internal series diode.



SERIES RF312/RF332

TYPICAL Single-Ended Signal Integrity Characteristics @ 20 Gbps

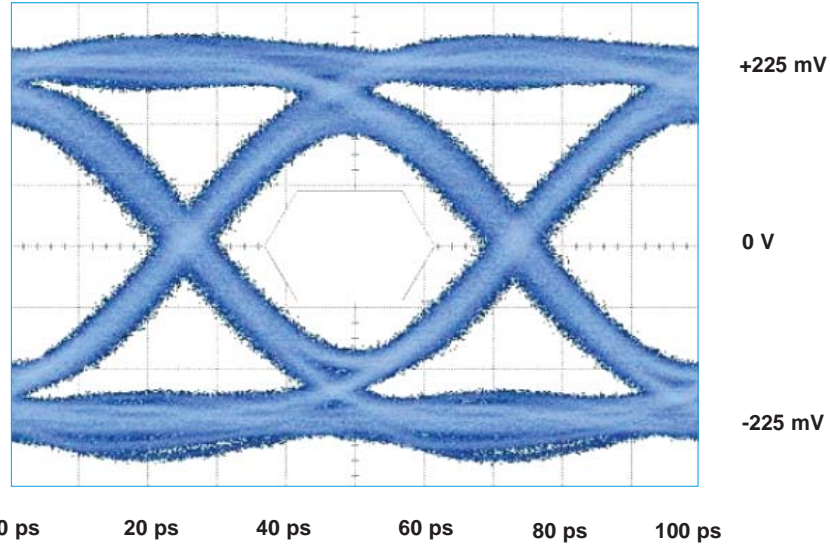

Bit Rate	Eye Height	Eye Width	Jitter _{P-P}
20 Gbps	191 mV	37 ps	10.22 ps