

450-3359 Teflon Insulated, thread mount socket, for .080 (2,03) diameter pins. Recommended mounting hole to suit 1/4-32 UNEF-2A thread.

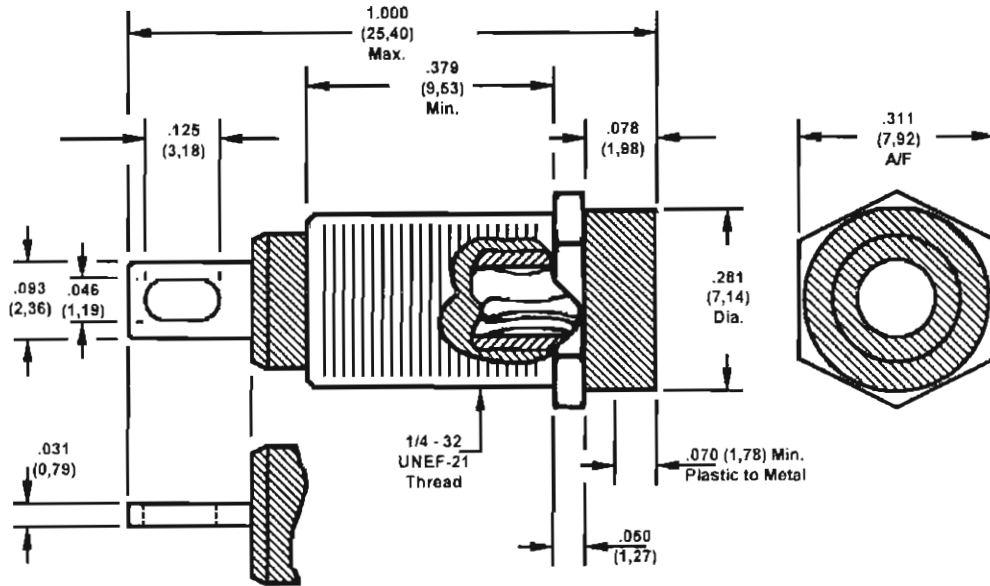

Min hole depth .540 (13,72)

How to order code
450-3359-01-03-19
 Basic Part No.

MATERIALS		
Component	Material	Finish(-03)
Body	Brass	Gold over Nickel
Spring	Beryllium copper	Gold over Nickel
Metal sleeve	Brass	Nickel
Insulator	Teflon	White

Other colours to order - consult factory

Unassembled Mounting Hardware		
Component	Material	Finish
Mounting nut, hexagonal	Brass	Nickel
Internal tooth lockwasher	Phosphor bronze	Nickel

ADDITIONAL INFORMATION	
Basic Part No	Dielectric withstanding voltage (VRMS)
450-3359-01-03-XX	3000

Teflon is a registered trademark of Dupont